

DIN-Rail Mount, Central Time Clock and Main Automation Controller. It is the smart system servant that assist and monitor temperature, events, energy consumption, patterns, with main Targets: maintain, safeguard, protect and economize. It Can Trigger prayer announcements, reminders, alerts, macros, and moods. Each Logic module Consist of 240 tables, Each Table of 4 programmable Logic Lines totaling up to 960 Line of Logics using simplified (and, Or Nand , Nor, with 255 Flags). logical condition consist of trigger combinations like: time, scene Light channel status, curtain status, room temperature, security mode, day night, time... and so on
Added function: Improved Logic Table Configuration and Viewing of used against available flags.

Technical data



Time Clock

Built in time clock with central Broadcast function.
DTS day time adjustment
Muslim 5 Prayer Times function according to city Long and Lat.

Logic Lines

Total 960 logic lines: 240 Tables, each 4 Logic lines.

Logic Commands

Simplified logic commands like: (if, or, nand, nor +255 Flags)

Control IO

3 x Advanced RS485 C-BUS serial port links (both train & screw link types)

Upgrade IO

1 x mini USB port (to connect to special programming board)

User Controls

- LED status indicator/channel
- Diagnostic LED+ BROADCAST

Programming

- Advanced Software Configuration & Programming

Compliance

CE Mark EMC

Operation Protection

- BUS Rv. Polarity Protection
- BUS Short Circuit Protection

Trigger Conditions

Logical trigger or command conditions consist of trigger combinations like: time, scene Light channel status, curtain status, room temperature, security mode, day, night, flag...etc.

SBUS DC Supply

24VDC with flexible tolerance between 8-36VDC. Flexible ability to add power supply as to be needed any where
Power consumption: 15mA

Installation

- 35mm DIN-Rail Mount Ready
- Wall Mount Ready (4P)

Operating Environment

0° to 45°C ambient temperature
20% to 93% RH

Enclosure & Size

Polycarbonate, DIN-rail (4 Unit)

Dimensions & Weight

W 91mm x L 73mm x H 75mm
Packed weight 0.22 kg



www.smartsentido.com

Load compatibility

- lights
- Music
- Temperature
- Moods
- SMS
- Announcement
- Media
- Pumps
- FAN
- Curtains
- Access
- Security
- Scenes
- Genset

commercial



2022020400945,5

Electrical Diagram

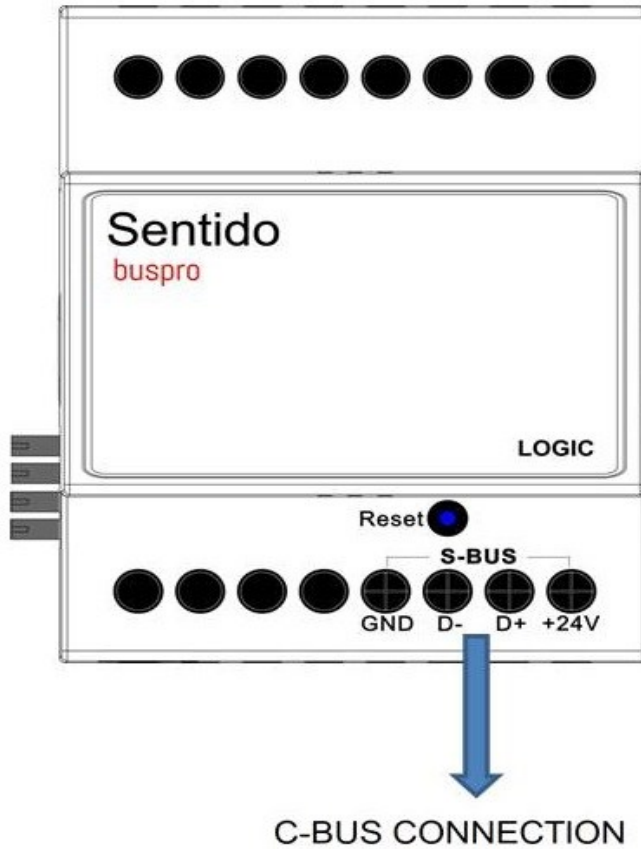



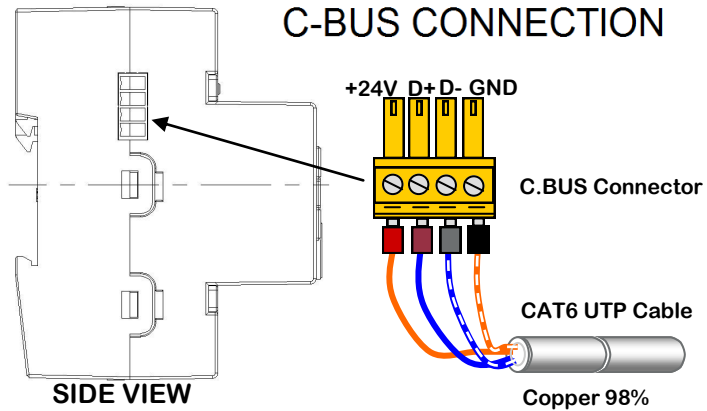





PROSPECTIVE



SIDE VIEW

UTP core colors

C.BUS +24V		orange
C.BUS GND		w/orange
C.BUS D+		blue
C.BUS D-		w/blue
Spare		green
Spare		w/green
Spare +12v		brown
Spare -12V		w/brown

